

LOWRANCE[®]

SpotlightScan[™]

Installation Manual

ENGLISH



Preface

As Navico is continuously improving this product, we retain the right to make changes to the product at any time which may not be reflected in this version of the manual. Please contact your nearest distributor if you require any further assistance.

It is the owner's sole responsibility to install and use the instrument and transducers in a manner that will not cause accidents, personal injury or property damage. The user of this product is solely responsible for observing safe boating practices.

NAVICO HOLDING AS AND ITS SUBSIDIARIES, BRANCHES AND AFFILIATES DISCLAIM ALL LIABILITY FOR ANY USE OF THIS PRODUCT IN A WAY THAT MAY CAUSE ACCIDENTS, DAMAGE OR THAT MAY VIOLATE THE LAW.

Governing Language: This statement, any instruction manuals, user guides and other information relating to the product (Documentation) may be translated to, or has been translated from, another language (Translation). In the event of any conflict between any Translation of the Documentation, the English language version of the Documentation will be the official version of the Documentation. This manual represents the product as at the time of printing. Navico Holding AS and its subsidiaries, branches and affiliates reserve the right to make changes to specifications without notice.

Copyright

Copyright © 2014 Navico Holding AS.

Warranty

The warranty card is supplied as a separate document.

In case of any queries, refer to the brand web site of your display or system: www.lowrance.com

Regulatory Statements

The Spotlight complies with the following regulations:

- CE under EMC directive 2004/108/EC
- Level 2 devices of the Radio communications (Electromagnetic Compatibility) standard 2008

The relevant Declaration of Conformity is available in the following websites under model documentation section:

www.lowrance.com.

About this manual

The manual does not cover basic background information about how the heading sensor works. Such information is available from our web site:

<http://www.lowrance.com/Support/Library/>

Important text that requires special attention from the reader is emphasized as follows:

- **Note:** Used to draw the reader's attention to a comment or some important information.





Warning: Used when it is necessary to warn personnel that they should proceed carefully to prevent risk of injury and/or damage to equipment/personnel.

Trademarks

- 'NMEA 2000' is a registered trademark of the National Marine Electronics Association.
- 'Navico', 'Lowrance', and 'SpotlightScan' are trademarks of Navico, registered in the US and other countries.
- 'MotorGuide' is a registered trademark of Brunswick Corporation.
- 'Minn Kota' is a registered trademark of Johnson Outdoors Marine Electronics, Inc.

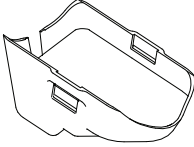
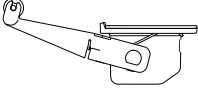
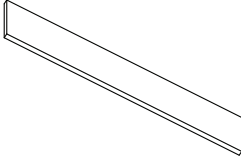
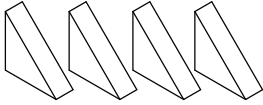
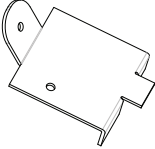
Contents

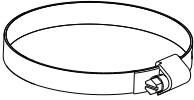
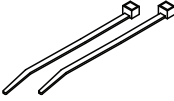
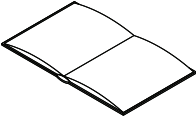
SpotlightScan transducer 	Position sensor 
Roller plate 	Adhesive Foam pads (x4) 
Mounting plate 	No. 6 (6/32) screw 
No. 6 nut 	Hose clamp 
Zip ties (x2) 	Manual 

Installation

⚠ Warning: Read all the installation instructions before installing the SpotlightScan system. The position sensor must be installed exactly as specified in this document or the system will not work correctly. If you have any concerns, have your system installed by a qualified technician.

This document covers installation of the SpotlightScan system on all MotorGuide and Minn Kota cable-steer trolling motors.

⚠ Warning: Disconnect power to the trolling motor before installing the SpotlightScan transducer.

Installing the transducer

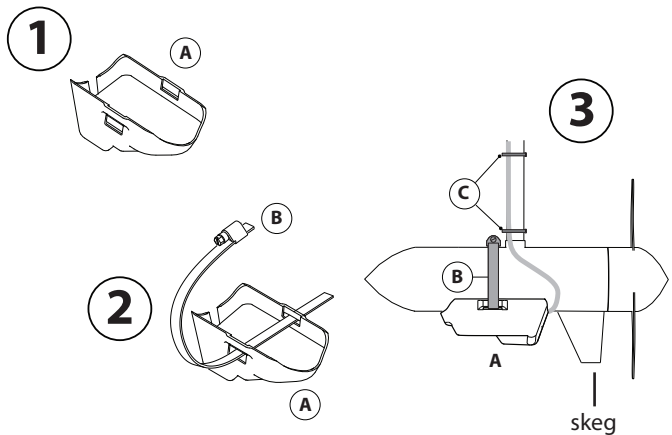
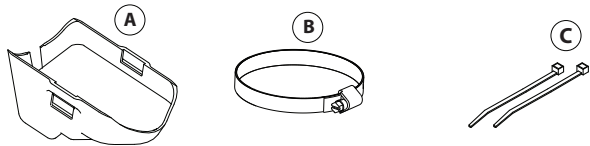

→ **Note:** Install the SpotlightScan transducer so it is parallel with the waterline. Make sure the skeg on the trolling motor is lined up between the two alignment marks on the bottom of the SpotlightScan transducer.

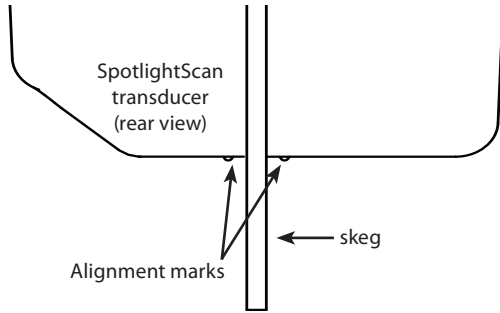

Rear view of the skieg lined up between alignment marks on the SpotlightScan transducer.

Installing the position sensor

The position sensor will be installed on the foot pedal base. It must be installed so the lever arm is in constant contact with the underside of the foot pedal.



Warning: We recommend walking through the installation before installing the sensor. Once the attached adhesive on the sensor bonds with the mounting surface, it will be very difficult to remove and will not adhere properly after removal.

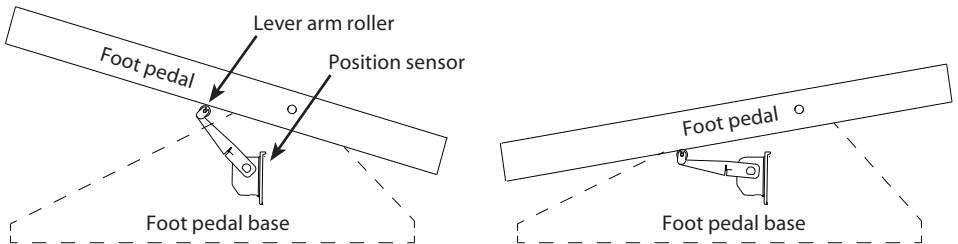

The lever arm roller must be positioned against a smooth, flat surface to operate correctly.

Foot pedal adjustment

Make sure your foot pedal steering cable does not have any slack; otherwise, the quality of SpotlightScan images may be diminished. Refer to your trolling motor manual for information about tightening the steering cable.

- **Note:** SpotlightScan position alignment should be based on the direction the trolling motor is pointing. Do not use the arrow indicator on the trolling motor head as a reference as it may not be aligned correctly with the trolling motor. Refer to the SpotlightScan operation manual for more information.

MotorGuide Tour series foot pedal



Make sure the pedal is in the heel down position before turning it upside down.

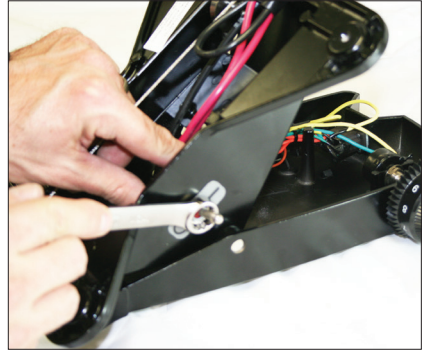

Removing the switch on the side of the foot pedal base will make it easier to install the mounting plate.

1. Remove power from the trolling motor and deploy the motor so it can turn freely.
2. Make sure the pedal is in the heel down position.
3. Turn the foot pedal upside down.
4. Remove the switch from the side of the foot pedal base.

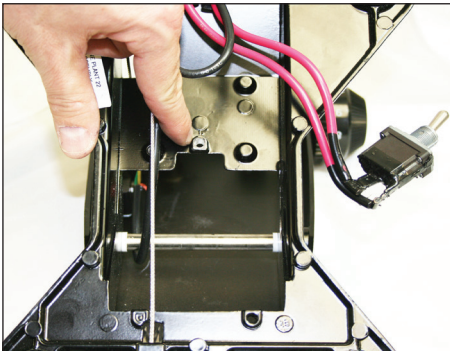

This pre-existing mounting hole will be used when fastening the mounting plate to the pedal housing.

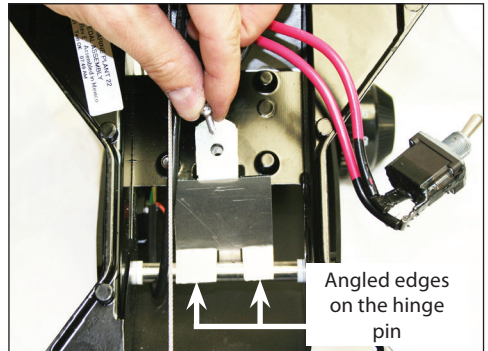

Place the angled edges of the mounting plate over the hinge pin on the foot pedal.

5. Place the angled edges of the mounting plate over the hinge pin on the foot pedal.
6. Align the attachment tab of the mounting plate with the existing mounting hole on the bottom of the foot pedal base.
7. Fasten the mounting plate to the underside of the base using the supplied No. 6 (6/32) screw and nut.
8. Reinstall the switch on the side of the foot pedal base.
9. Turn the foot pedal right-side up.

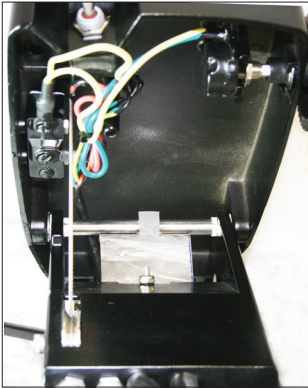

Mounting plate view with pedal turned right-side up.

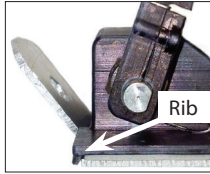
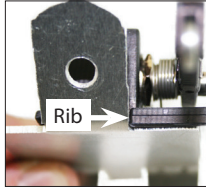

The plate will be installed on the base before the sensor is attached. These images show only how the sensor fits on the plate.

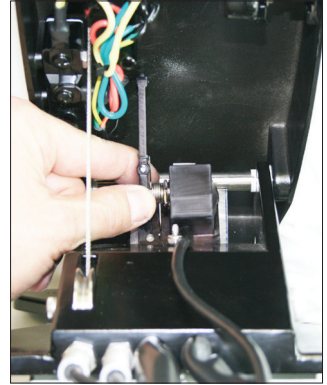

Pull the lever arm back when installing the position sensor on the mounting plate.

10. Make sure the mounting plate is clean and dry. Clean the plate with rubbing alcohol, if necessary.
11. Pull the lever arm back and align the position sensor on the mounting plate using the attached adhesive strip.
 - Make sure the rib on the position sensor overlaps the widest angled edge on the mounting plate.
12. Connect the position sensor cable to your NMEA 2000 network.

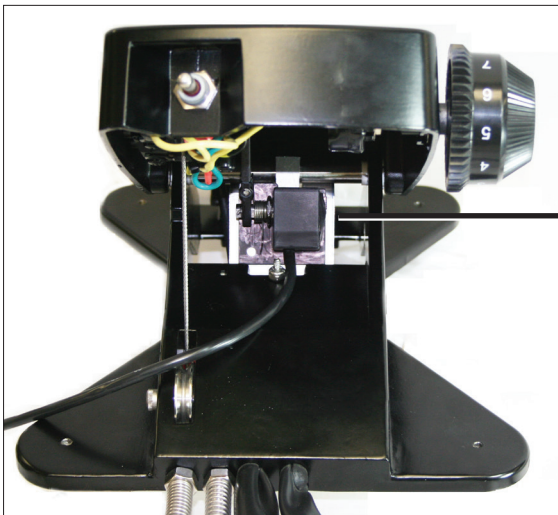

The rib must be flush with the top edge of the mounting plate.

The rib must butt against the alignment tab.

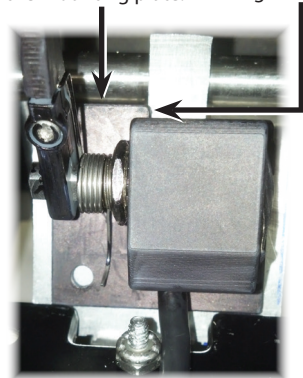

MotorGuide plastic foot pedal

There is not a solid contact point for the position sensor lever arm roller on the underside of the MotorGuide plastic pedal.

Use the supplied adhesive foam pads and the plastic roller plate to create a contact point for the lever arm.



Make sure the pedal is in the toe down position before turning it upside down.



With the pedal upside down, remove the base plate.

1. Remove power from the trolling motor and deploy the motor so it can turn freely.
2. Turn the foot pedal upside down with pedal in the toe down position. You will install the position sensor under the heel side of the foot pedal.
3. Remove the base plate from the bottom of the foot pedal.
4. Move the wiring harness away from the position sensor mounting location.

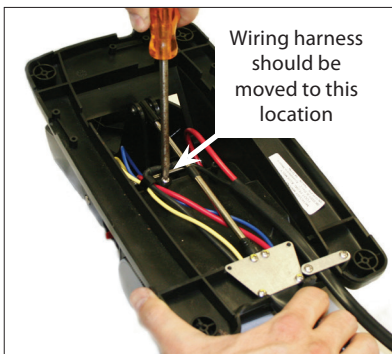

Wiring harness should be moved to this location

The wiring harness should be moved away from the area where the position sensor will be installed.

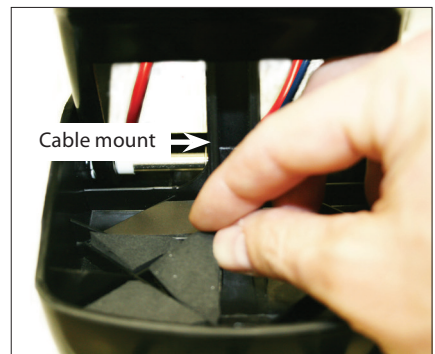

The adhesive foam pads will be installed in the four cavities next to the cable mount.

5. Make sure the mounting surface is clean and dry. Clean the surface with rubbing alcohol, if necessary.
6. Install the adhesive foam padding in the four cavities next to the cable mount using the attached adhesive.

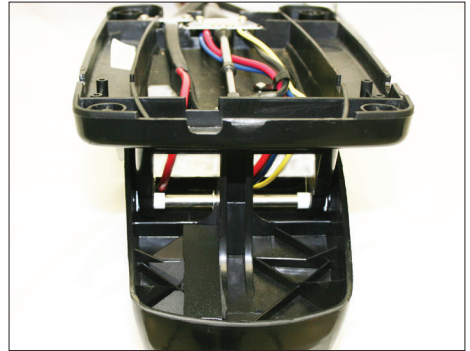
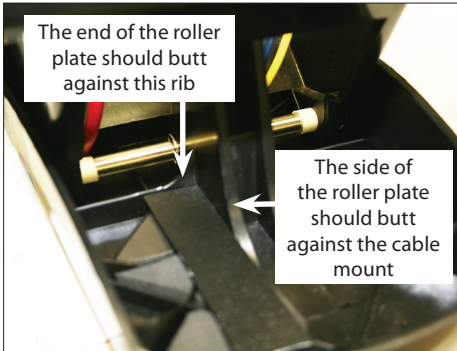

Front view of installed roller plate.

The roller plate should be flush with the rib on the housing and the side of the cable mount. The textured side of the plate should be in contact with the foam pads.

7. Position the plastic roller plate so it butts against the rib in front of the hinge pin and against the cable mount, as shown above. Make sure the textured side of the plate bonds securely with the adhesive on the foam padding.

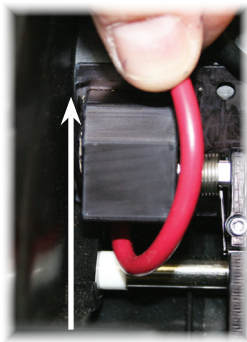

The sensor should be flush with the side of the base housing (top view).

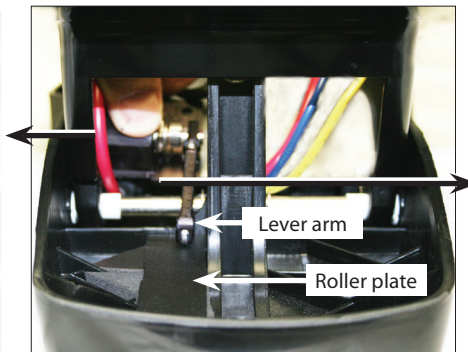

Install the sensor so the rib grips the edge of the base housing. Make sure the side of the sensor is flush with the side of the housing.

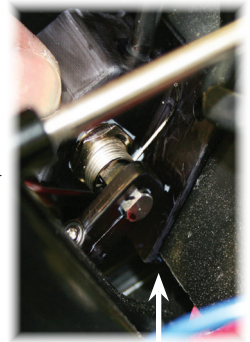

The rib on the sensor should grip this edge on the base housing (side view).

8. Pull the lever arm back and install the position sensor on the foot pedal base using the attached adhesive.
9. Reinstall the base plate.
10. Connect the position sensor to your NMEA 2000 network.

Minn Kota foot pedal

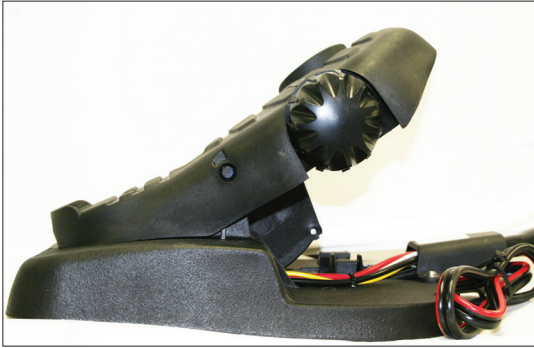

The pedal should be in the heel down position.

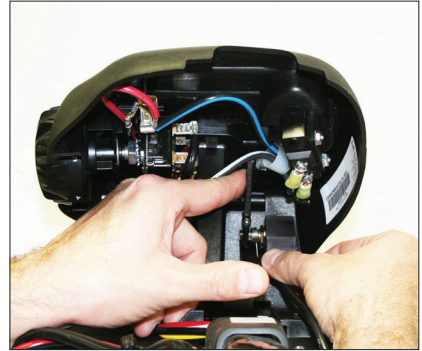

Move the lever arm back when installing the position sensor.

1. Remove power from the trolling motor and deploy the motor so it can turn freely.
2. Make sure the mounting surface is clean and dry. Clean the surface with rubbing alcohol, if necessary.
3. Pull the lever arm back and place the rib of the position sensor on the edge of the base housing as shown below. Make sure the side of the rib butts against the housing.
4. Connect the position sensor cable to your NMEA 2000 network.

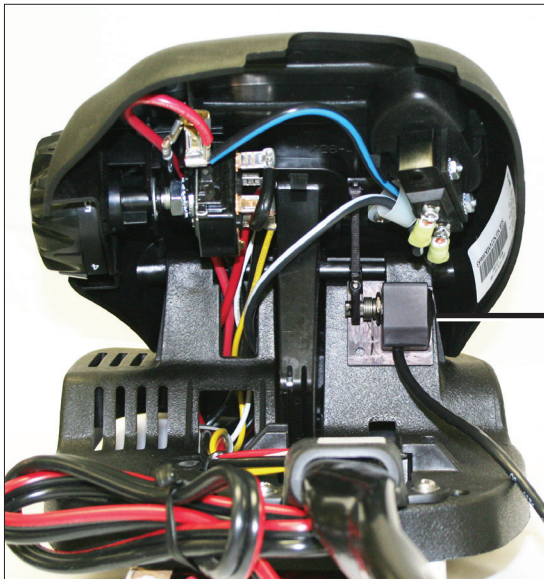

The side of the sensor rib should be flush against this part of the base housing.

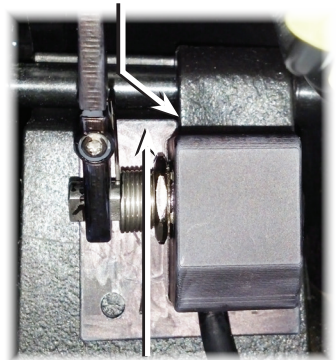

The rib should grip this edge of the base housing.

Wiring diagrams

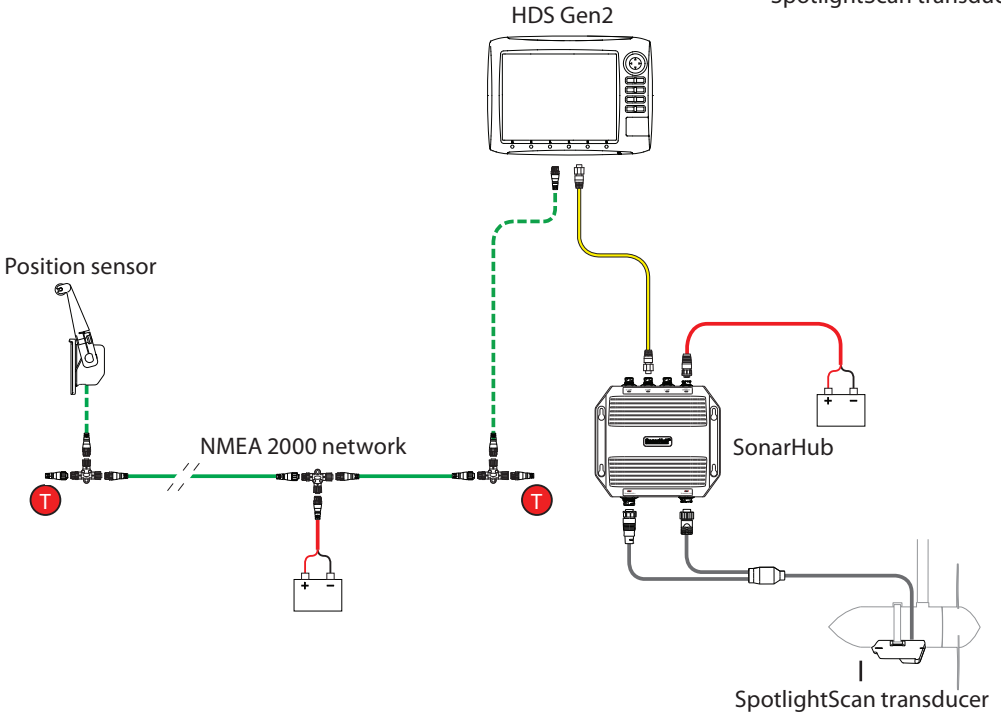
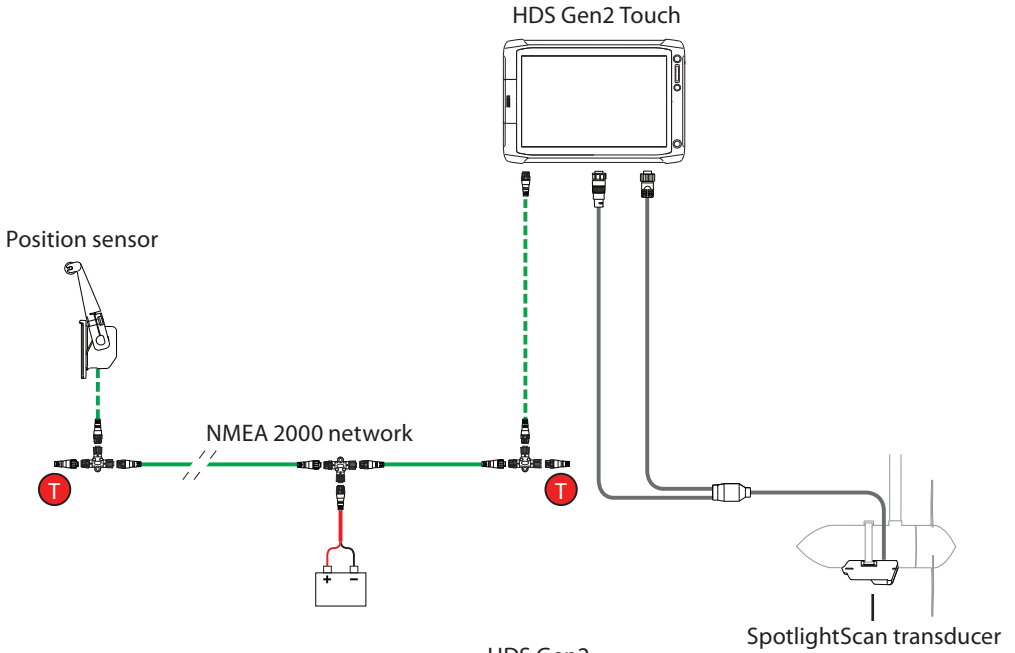



LOWRANCE®

